

Yealink T57W Prime Business Phone



Yealink Quick Start Guide

Package Contents

The following items are included in your package. If you find anything missing, contact your system administrator.

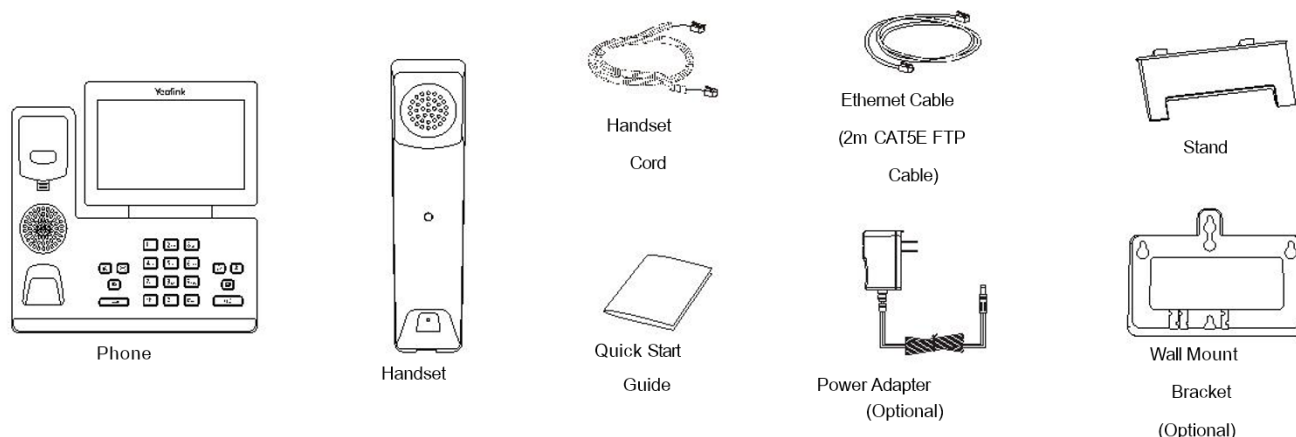

Note: We recommend that you use the accessories provided or approved by Yealink. The use of unapproved third-party accessories may result in poor performance.

Assembling Your Phone

1. Attach the stand and adjust the angle of the screen.

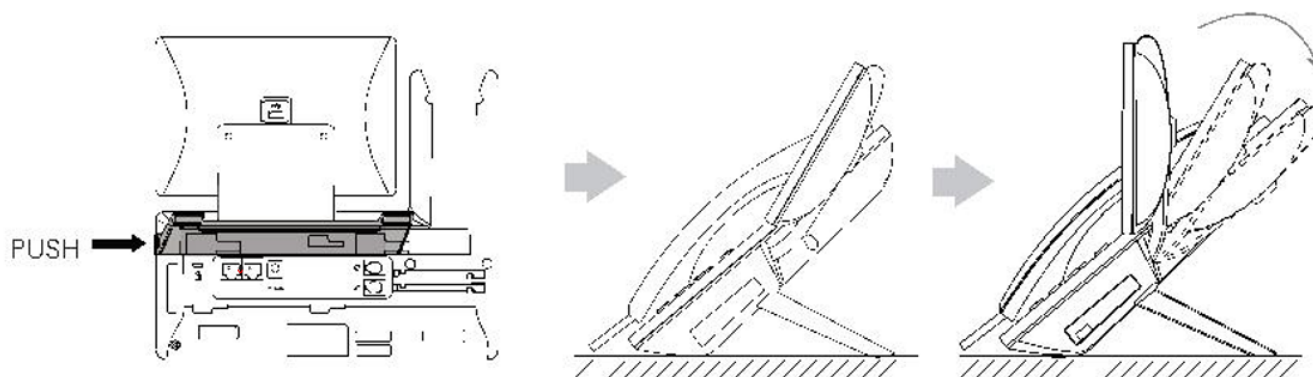

Note: You can also mount the phone to a wall.

2. Connect the handset and optional headset.

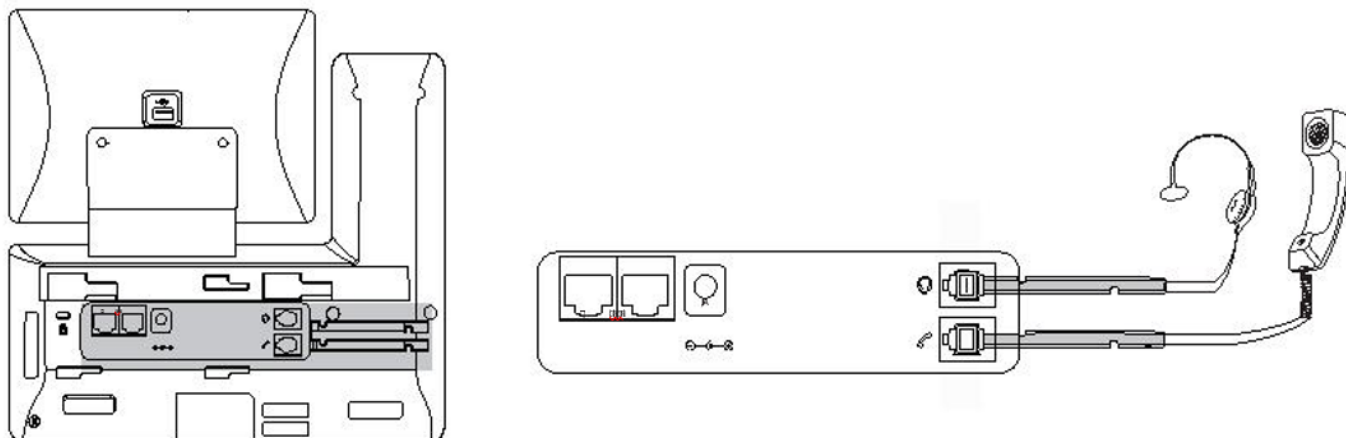

3. Optional: Connect the USB devices

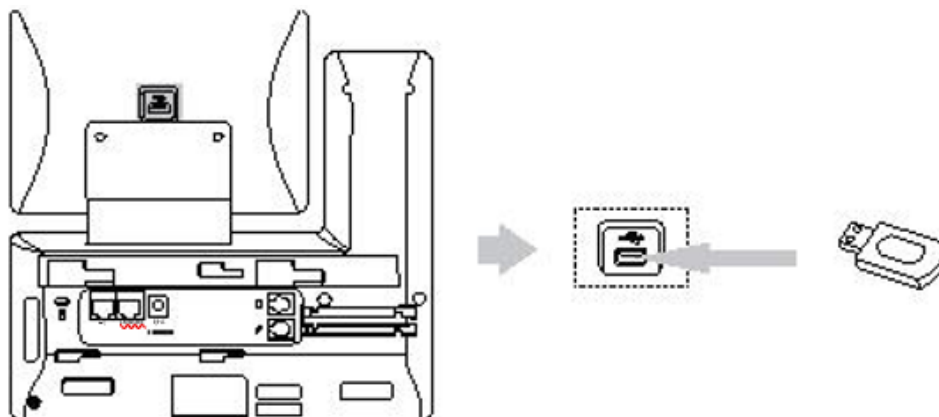

Note: The USB port can also be used to connect other USB devices, such as EXP50, USB headset and so on.

4. Connect the AC power or PoE

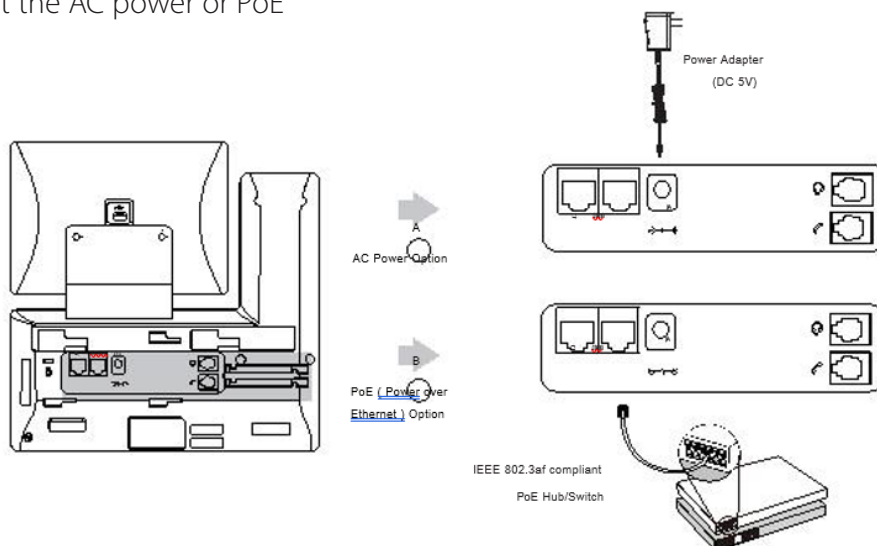

Note: The phone should be used with Yealink original power adapter (5V/2A) only. The use of the third-party power adapter may cause the damage to the phone.

5. Connect to the network

- ▶ Connect to the wired network

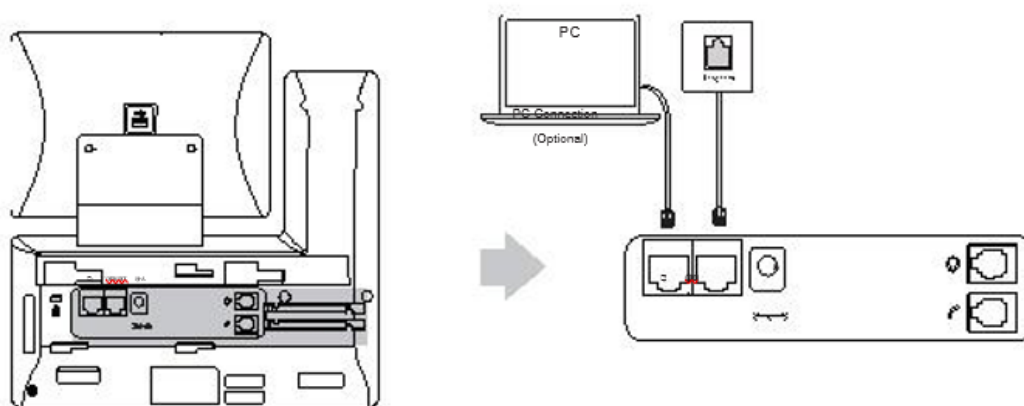

Note: If you are connecting a PC to your phone, we recommend that you use the Ethernet cable provided by Yealink.



After the phone is connected to the network and supplied with power, it automatically begins the initialization process. After startup, the phone is ready for use. You can configure the phone via phone user interface or web user interface.

Configuring Your Phone

DHCP: By default, the phone attempts to contact a DHCP server in your network to obtain its valid network settings, for example, IP address, subnet mask, gateway address and DNS address. Set DHCP Option 66 to <https://commportal.airespring.com/sip-ps/>

Using Basic Call Functions

Placing a Call

Using the handset

1. Pick up the handset.
2. Enter the number, and then tap **Send**.

Using the speakerphone:

1. With the handset on-hook, press .
2. Enter the number, and then tap **Send**.

Using the headset:

1. With the headset connected, press  to activate the headset mode.

Note: During a call, you can alternate between the headset, hands-free speakerphone and handset modes by pressing the **HEADSET** key, the **Speakerphone** key or by picking up the handset. Headset mode requires a connected headset.

2. Enter the number, and then tap **Send**. Enter the number, and then tap **Send**.

Answering a Call

Using the handset:

- ▶ Pick up the handset

Using the speakerphone:

- ▶ Press 

Using the headset:

- ▶ Press 

Note: You can reject an incoming call by tapping **Reject**.

Ending a Call

Using the handset:

- ▶ Hang up the handset or tap **End Call**



Using the speakerphone:

- ▶ Press  or **End Call**



Using the headset:

- ▶ Tap **End Call**

Redialing a Call:

- ▶ Press  to enter the Placed Calls list, and then tap the desired entry.
- ▶ Press  twice when the phone is idle to dial out the last dialed number.

Muting and Un-muting a Call:



- ▶ Press  to mute the microphone during a call.
- ▶ Press  again to un-mute the call.

Holding and Resuming a Call

To Hold a call:

- ▶ Press  or **Hold** during an active call.



To Resume the call, do one of the following:

- ▶ If there is only one call on hold, press  or **Resume**.
- ▶ If there is more than one call on hold, select the desired call, and then press  or **Resume**.



Transferring a Call:

You can transfer a call in the following ways:



Performing a Blind Transfer:

1. Press  or **Transfer** during an active call. The call is placed on hold.
2. Enter the number you want to transfer to.
3. Press  or **B Transfer**.

Performing a Semi-Attended Transfer

1. Press  or **Transfer** during an active call. The call is placed on hold.
2. Enter the number you want to transfer to, and then press **Send**.
3. Press  or **Transfer** when you hear the ring-back tone.

Performing an Attended Transfer

1. Press  or **Transfer** during an active call. The call is placed on hold.
2. Enter the number you want to transfer to, and then press **Send**.
3. Press  or **Transfer** when the second party answers.

Initiating a Conference Call

Note: You can split the conference call into two individual calls by tapping **Split**.

1. Tap **Conference** during an active call. The call is placed on hold.
2. Enter the number of the second party, and then tap **Conference**.
3. Tap **Conference** again when the second party answers. Three parties are now joined in the conference.

Listening to Voice Mails

Message waiting indicator on the idle screen indicates that one or more voicemail messages are waiting at the message center. The power indicator LED slowly flashes red.

To listen to voice messages:

1. Press  or **Connect**.
2. Follow the voice prompts to listen to your voice messages.

Customizing Your Phone

Managing Call History

1. Press **History**.
2. Select an entry from the list.
3. Tap **i** after the desired entry, and then you can do the following:
 - ▶ Press **Send** to call the entry.
 - ▶ Press **Delete** to delete the entry from the list.
 - ▶ Press **Option**, you can also do the following:
 - Select **Detail** to view detailed information about the entry.
 - Select **Add to Contacts** to add the entry to the local directory.
 - Select **Delete All** to delete all entries from the list.

Managing Contact Directory

Adding a contact:

1. Press **Directory**.
2. Press **Add** to add a contact.
3. Enter a unique contact name in the **Name** field and contact numbers in the corresponding fields.
4. Press **Save** to accept the change.

Editing a contact:

1. Press **Directory**.
2. Tap **i** after the desired entry.
3. Edit the contact information.
4. Press **Save** to accept the change.

Deleting a contact:

1. Tap **Directory**.
2. Tap **i** after the desired entry and then tap **Delete**.
3. Press the **OK** when the LCD screen prompts "Delete selected item?".

Adjusting the Volume

- ▶ Press  to adjust the volume.

Setting Ring Tones:

1. Navigate to **Menu->Basic->Sound->Ring Tones**.
2. Select **Common** or the desired account.
3. Select the desired ring tone.
4. Tap **Save** to accept the change.