

Yealink Prime Business Phone SIP-T54W

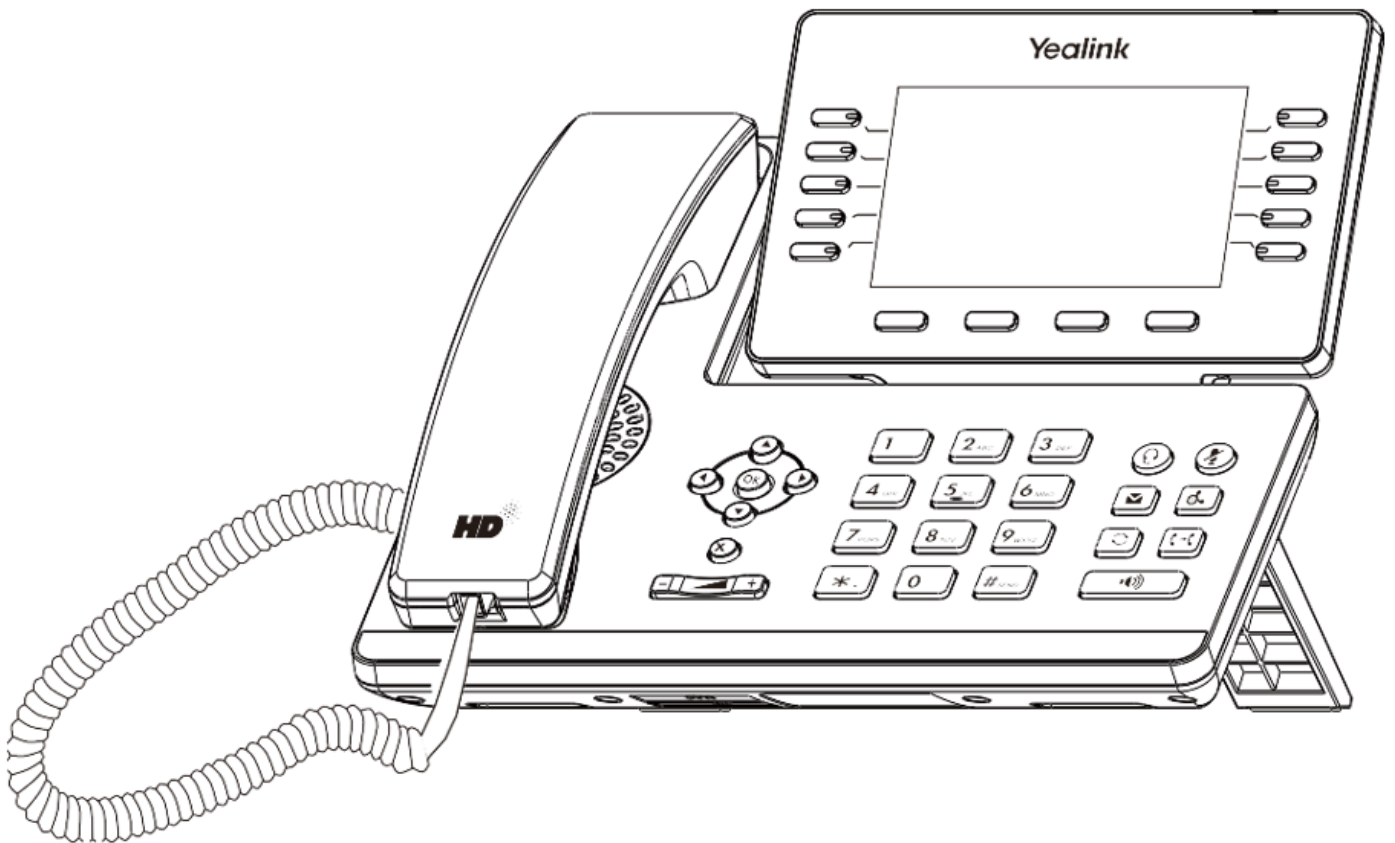

Yealink QUICK START GUIDE

Package Contents

The following items are included in your package. If you find anything missing, contact your system administrator.

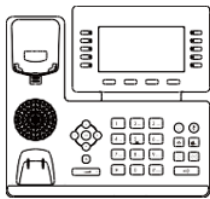

IP Phone



Handset



Handset Cord



Quick Start Guide



*Ethernet Cable
(2m CAT5E UTP Cable)*



*Power Adapter
(Optional)*

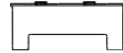

Stand

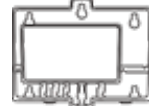

*Wall Mount Bracket
(Optional)*

Note: We recommend that you use the accessories provided or approved by Yealink. The use of unapproved third-party accessories may result in reduced performance.

Assembling the Phone

1. Attach the stand and adjust the angle of the screen

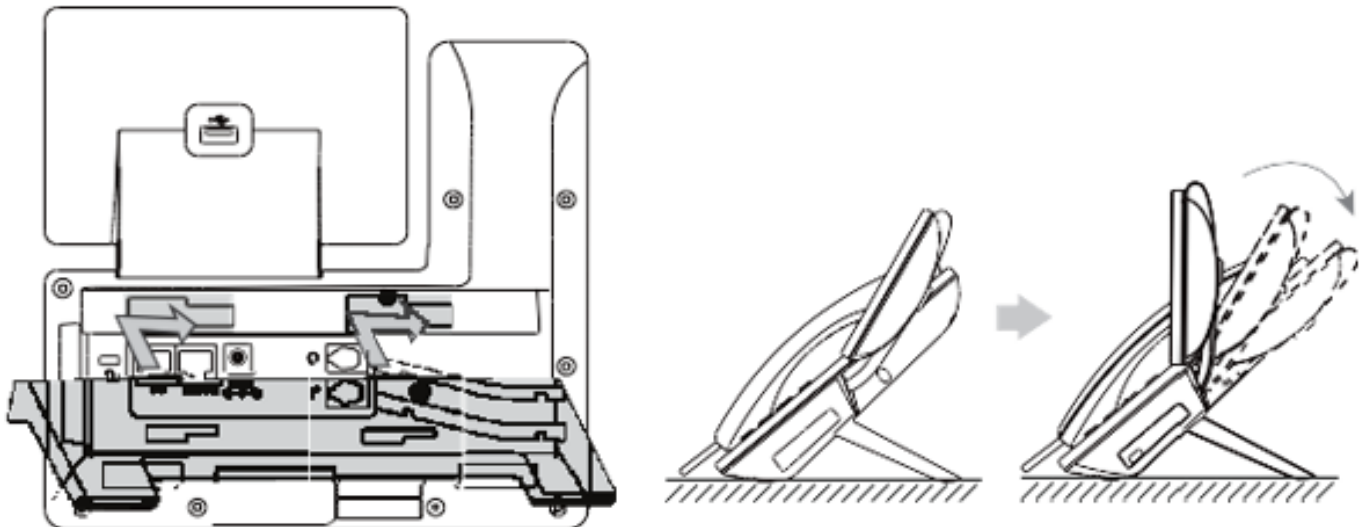

Note: You can also mount the phone to a wall.

2. Connect the handset and optional headset

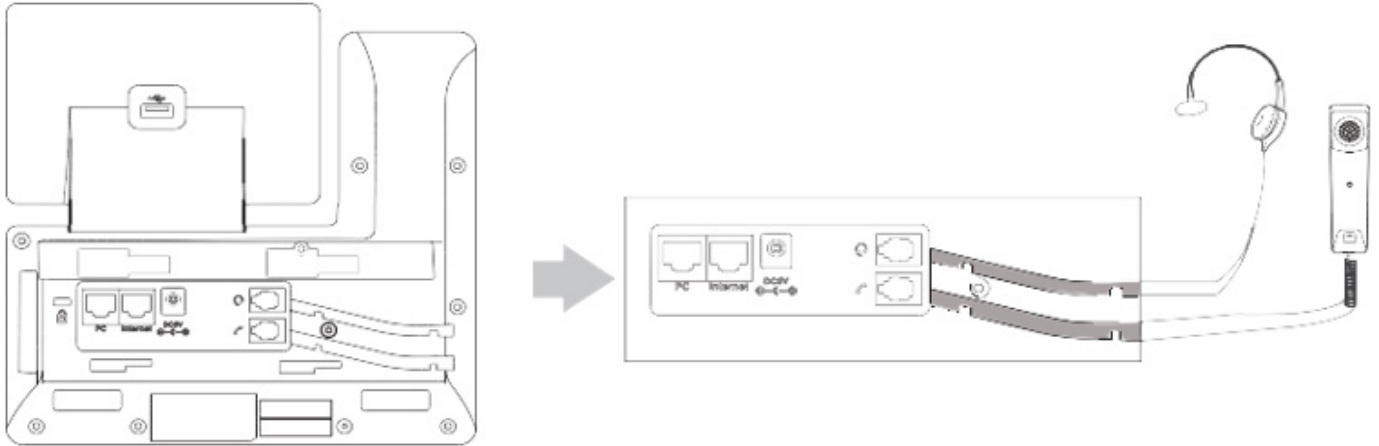

3. Optional: Connect the USB devices

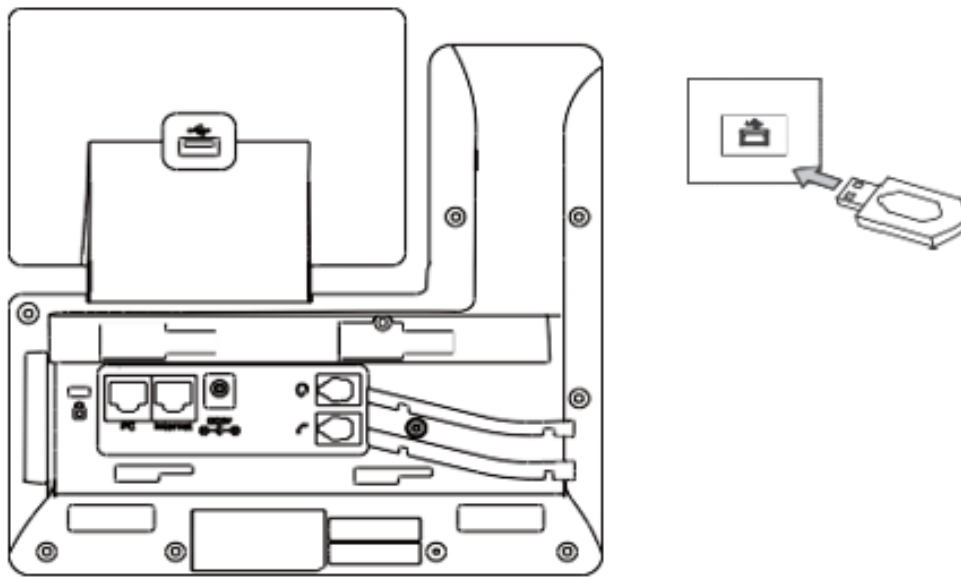

Note: The USB port can also be used to connect other USB devices, such as EXP50, USB headset and so on.

You have two options for network and power connections. Your system administrator will advise you which one to use

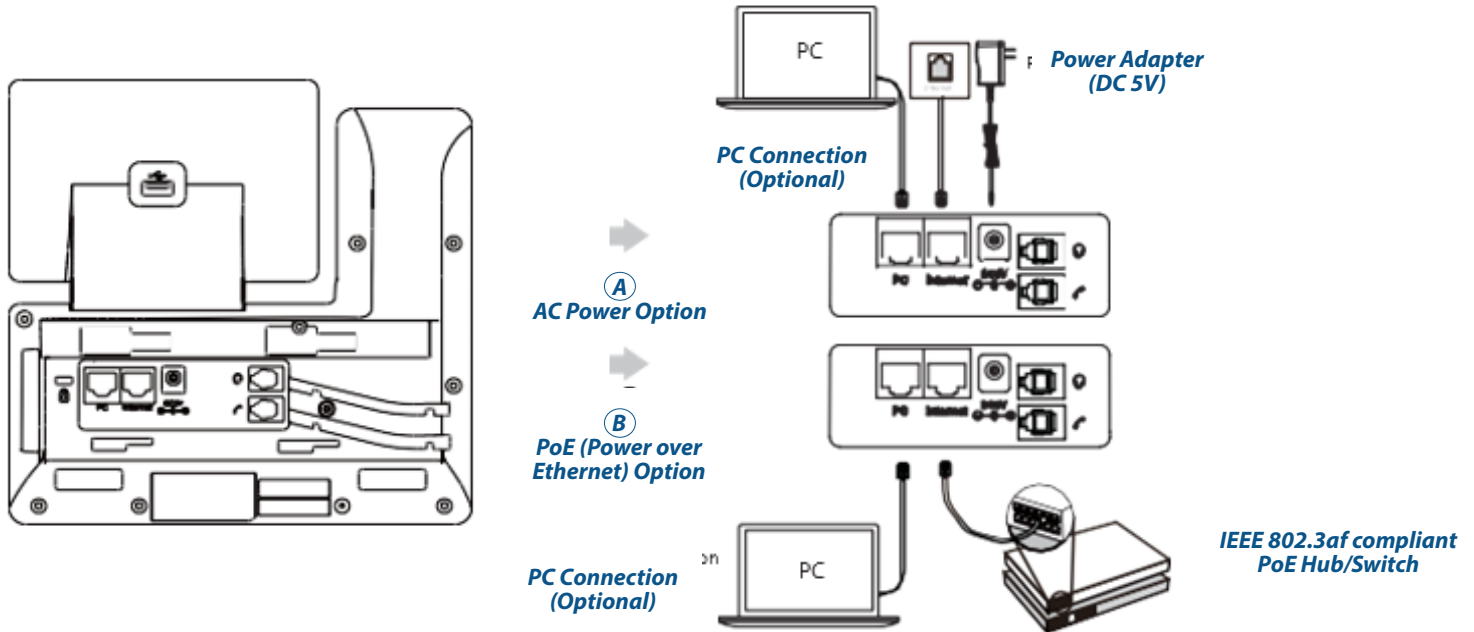

Note: The IP phone should be used with Yealink original power adapter (5V/2A) only. The use of the third-party power adapter may cause the damage to the phone. If you are connecting a PC to your phone, we recommend that you use the Ethernet cable provided by Yealink. If inline power (PoE) is provided, you don't need to connect the power adapter. Make sure the hub/switch is PoE-compliant.

Starting the Phone

After the phone is connected to the network and supplied with power, it automatically begins the initialization process. After startup, the phone is ready for use. You can configure the phone via phone user interface or web user interface.



Basic Call Features

Placing a Call

Using the handset:

1. Pick up the handset.
2. Enter the number, and then press **Send**.

Using the speakerphone:

1. With the handset on-hook, press .
2. Enter the number, and then press **Send**.

Using the headset:

1. With the headset connected, press  to activate the headset mode.
2. Enter the number, and then press **Send**.

Note: During a call, you can alternate between the headset, hands-free speakerphone and handset modes by pressing the HEADSET key, the Speakerphone key or by picking up the handset. Headset mode requires a connected headset.

Answering a Call

Using the handset:

Pick up the handset.

Using the speakerphone:

Press .

Using the headset:

Press .

Note: You can reject an incoming call by pressing **Reject**.

Ending a Call

Using the handset:

Hang up the handset or press **End Call**.





Using the speakerphone:

Press  or **End Call**.



Using the headset:

Press **End Call**.

Redialing a Call

- ▶ Press  to enter the **Placed Calls** list, press  or  to select the desired entry, and then press  or **Send**.
- ▶ Press  twice when the phone is idle to dial out the last dialed number.

Muting and Un-muting a Call





- ▶ Press  to mute the microphone during a call.
- ▶ Press  again to un-mute the call.

Holding and Resuming a Call

To hold a call:

Press  or the **Hold** soft key during an active call.



To Resume the call, do one of the following:

- ▶ If there is only one call on hold, press  or **Resume**.
- ▶ If there is more than one call on hold, press  or  to select the desired call, and then press  or **Resume**.



Transferring a Call

You can transfer a call in the following ways:



Performing a Blind Transfer

1. Press  or **Transfer** during an active call. The call is placed on hold.
2. Enter the number you want to transfer to.
3. Press  or **B Transfer**.

Performing a Semi-Attended Transfer

1. Press  or **Transfer** during an active call. The call is placed on hold.
2. Enter the number you want to transfer to, and then press **Send**.
3. Press  or **Transfer** when you hear the ring-back tone.



Performing an Attended Transfer

1. Press  or **Transfer** during an active call. The call is placed on hold.
2. Enter the number you want to transfer to, and then press **Send**.
3. Press  or **Transfer** when the second party answers.

Forwarding a Call**To enable call forward:**

1. Navigate to Menu->Features->Call Forward
2. Select the desired forward type:
 - Always Forward** --- Incoming calls are forwarded unconditionally
 - Busy Forward** --- Incoming calls are forwarded when the phone is busy
 - No Answer Forward** --- Incoming calls are forwarded if not answered after a period of time.

Note: You can split the conference call into two individual calls by pressing the **Split** soft key.

3. Enter the number you want to forward to. For **No Answer Forward**, press  or  to select the desired ring time to wait before forwarding from the **After Ring Time** field.
4. Press **Save** to accept the change.

Initiating a Conference Call

1. Press **Conference** during an active call. The call is placed on hold.
2. Enter the number of the second party, and then press **Send**.
3. Press **Conference** again when the second party answers. All parties are now joined in the conference.

Note: You can split the conference call into two individual calls by pressing **Split**.

Listening to Voice Mails



Message waiting indicator on the idle screen indicates that one or more voicemail messages are waiting at the message center. The power indicator LED slowly flashes red.

To listen to voice messages:

1. Press  or **Connect**.
2. Follow the voice prompts to listen to your voice messages.

Customizing Your Phone

Managing Call History

1. Press **History**.
2. Press  or  to select an entry from the list
3. Do the following
 - Press **Send** to call the entry.
 - Press **Delete** to delete the entry from the list.
 - Press **Option**, you can also do the following:
 - ▶ Select **Detail** to view detailed information about the entry.



- ▶ Select **Add to Contacts** to add the entry to the local directory.
- ▶ Select **Delete All** to delete all entries from the list.

Managing Contact Directory



Adding a contact:

1. Press **Directory**, and then select **All Contacts**.
2. Press **Add** to add a contact.
3. Enter a unique contact name in the **Name** field and contact numbers in the corresponding fields.
4. Press **Save** key to accept the change.

Editing a contact:

1. Press **Directory**, and then select **All Contacts**.
2. Press  or  to select the desired contact, press **Option** and then select **Detail** from the prompt list.
3. Edit the contact information.
4. Press **Save** to accept the change.

Deleting a contact:

1. Press **Directory** when the phone is idle, and then select **All Contacts**.
2. Press  or  to select the desired contact, press **Option** and then select **Delete** from the prompt list.
3. Press the **OK** soft key when the LCD screen prompts “Delete selected item?”.

Adjusting the Volume

- ▶ Press  to adjust the volume.